

Features

- Available in 30°, 60°, 90° V-port sizes
- Factory-installed digital positioning system for precise control
- 316SS 3-piece investment cast body
- RTFE (reinforced Teflon) ball seats
- Triple PTFE/Viton live loaded stem seals, adjustable
- IP67 weatherproof polyamide enclosure with UV protection
- Multi-voltage with auto-voltage sensing
- Long life brushless motor
- Highly visual dome style valve position indicator
- Anti-condensation heater
- Manual override
- DIN plug type electrical connections
- Two auxiliary limit switches to confirm valve position
- BSR Failsafe option available

Applications

V-port ball valves are used in applications requiring finer flow control than standard ball valves. Modulating control of water, air, oil and other media compatible with the materials of construction. Steam service up to 25 PSI with optional high temperature mounting kit. Suitable for vacuum service up to 29inchHg. Actuator is designed for 75% duty cycle.

Operation

Electric actuated valves with factory-installed digital positioning kit provide an accurate valve positioning function whereby the movement of the actuator is controlled by 4-20mA input control signal. Any change in the control input signal results in a corresponding and proportional change in the position of the actuator (valve disc). Flow is adjustable anywhere between 0-100%.

Construction

Valve Body	316 stainless steel ASTM A351 CF8M
Ball/Stem	316 stainless steel
Ball Seats	RTFE (reinforced Teflon)
Stem Seals	PTFE/ Viton
Anti-static Device	Ball to Stem (1/4" - 3") + Stem to Body (1-1/2" - 3")
Actuator Enclosure	Anti-corrosive polyamide, IP67 weatherproof
Position Indicator/Manual Override	Dome style indicator/manual polyamide knob
Fasteners	Stainless Steel
Auxiliary Limit Switches	2 x SPST 3A@125/250VAC, 30VDC resistive load

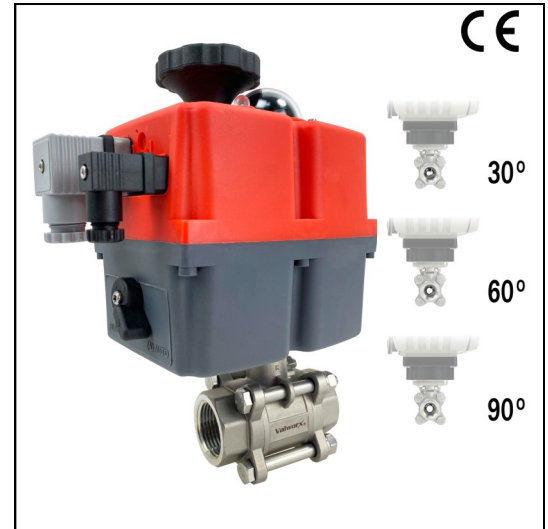

Description

Electric actuated 3-piece stainless steel V-port ball valves are investment cast with unrestricted flow and minimum pressure loss. Adjustable live loaded stem seal packing helps compensate for wear, pressure and/or temperature fluctuations, extending the cycle life of the valve. Standard corrosion resistant electric actuator includes a manual override, valve position confirmation switches (on-off units), thermostatically controlled anti-condensation heater, and over-torque protection.

V-port 316 stainless steel ball provides better linearity for enhanced flow control. Solid, machined construction for full pressure rating.

Approvals

Actuators

- CE– EN 60204-1:2006
- ISO5211 valve mounting

Valves

- Design: API 608
- Testing: API 598/ EN12266-1
- Threaded Connection: ASME B1.20.1 (NPT)/ ISO 228-1/ BS21
- Pressure/Temperature Rating: ASME B16.34
- Marking: MSS SP-25
- CE-PED 2014/68/UE

Construction Features

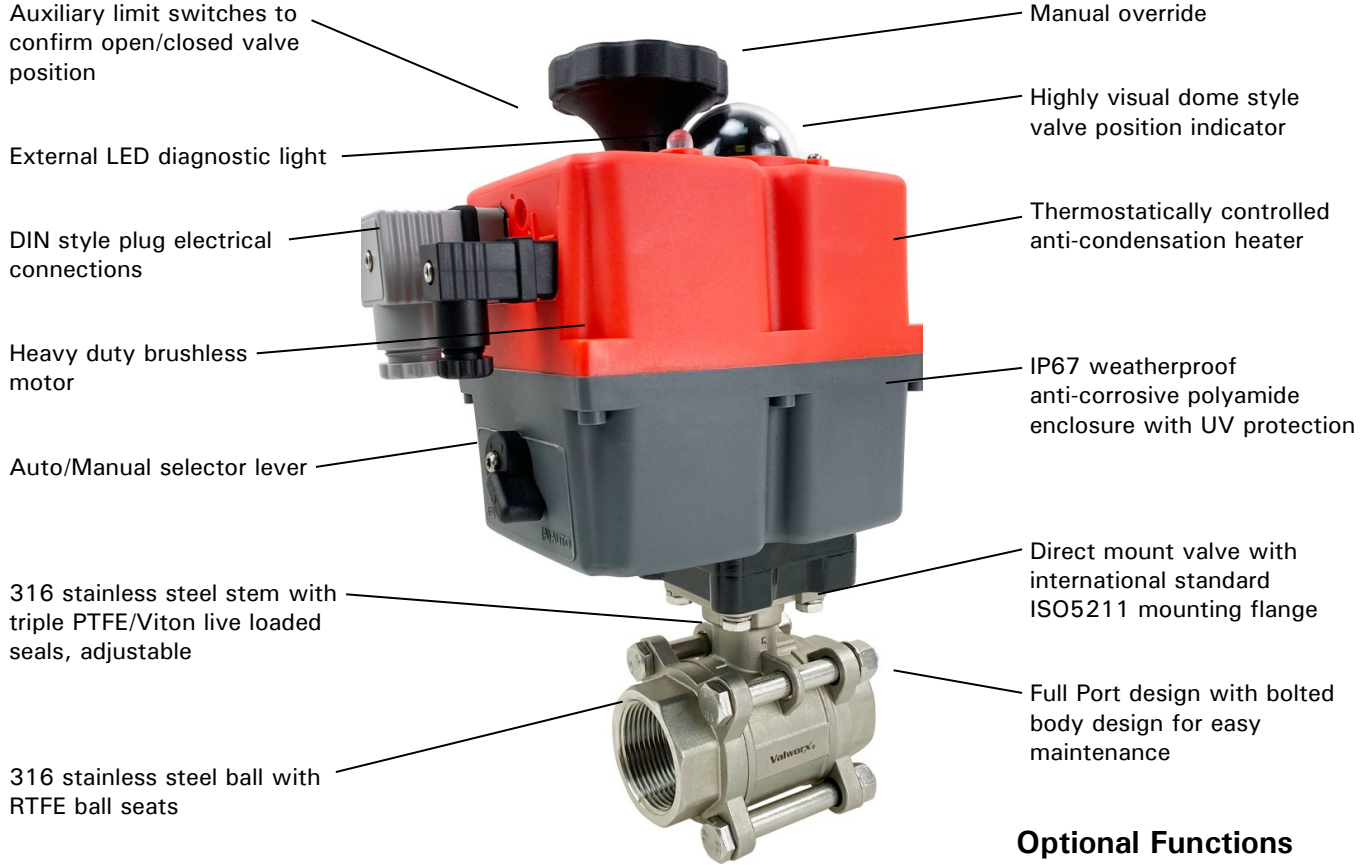

Optional Functions

- **BSR:** Battery Spring Return - actuator fails to a safe position with loss of external power

***Note: Actuated V- Port valve assembly come with factory installed digital positioning system. 4-20mA, normally closed. Other options available.**

V-Port Images



Pressure-Temperature

Valve Pressure Rating*: 1000 PSI CWP non-shock 1/4 to 2" sizes
 800 PSI CWP non shock 2-1/2 to 3" sizes
 Vacuum 29inHg

Ball Valve Temperature Rating: -4 to 392° F (-20 to 200° C)

Actuator Temperature Rating: -4 to +158° F (-20 to 70° C)

*See P/T chart (pages 3 & 4)

Specifications (English units)

Stock Number	Pipe Size (NPT)	Orifice Size (inch)	Pressure Max (PSI)*	Cycle Time per 90° (sec) +/- 10%	Enclosure Rating	Max. Current Draw (Amps)			
						110VAC	240VAC	24VAC	24VDC
24-240V AC/ DC ELECTRIC ACTUATED STAINLESS BALL VALVE: DPS Positioner version									
550502	1/4	0.5	1000	9	IP67	0.30	0.16	1.28	0.97
550503	3/8	0.5	1000	9	IP67	0.30	0.16	1.28	0.97
550504	1/2	0.6	1000	9	IP67	0.30	0.16	1.28	0.97
550506	3/4	0.8	1000	9	IP67	0.30	0.16	1.28	0.97
550508	1	1.0	1000	9	IP67	0.30	0.16	1.28	0.97
550510	1-1/4	1.3	1000	13	IP67	0.43	0.21	1.98	1.63
550512	1-1/2	1.5	1000	13	IP67	0.43	0.21	1.98	1.63
550516	2	2.0	1000	13	IP67	0.43	0.21	1.98	1.63
550520	2-1/2	2.6	800	29	IP67	0.33	0.18	1.50	1.22
550524	3	3.2	800	58	IP67	0.77	0.47	3.30	2.70

Cv is the GPM of water at 60° F that will pass through the valve with 1 PSI pressure drop

* Pressure at 100° F (reduced pressure at higher temperatures-see P/T chart)

Models with 240 volt range are single phase

Pressure/Temperature Chart (PSI/°F)

P/T Chart 1000 PSI				
PSI	1000	1000	100	0
°F	-4	50	330	392

P/T Chart 800 PSI				
PSI	800	800	100	0
°F	-4	50	330	392

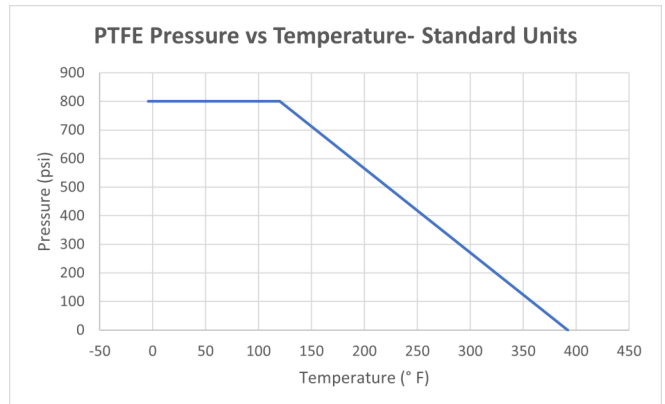
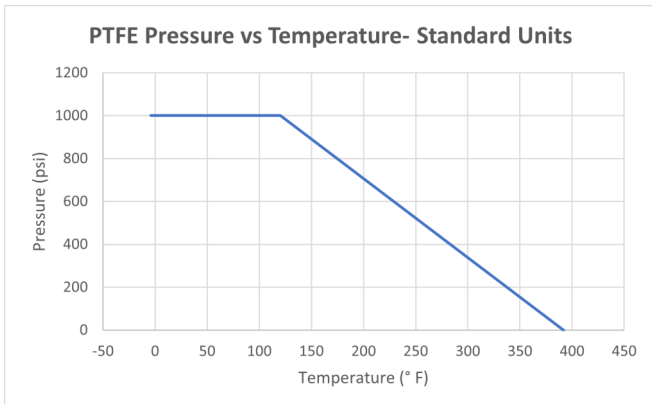

Specifications (Metric units)

Stock Number	Pipe Size (NPT)	Orifice Size (mm)	Pressure Max.(Bar)*	Cycle Time per 90° (sec) +/- 10%	Enclosure Rating	Max. Current Draw (Amps)			
						110VAC	240VAC	24VAC	24VDC
24-240V AC/ DC ELECTRIC ACTUATED STAINLESS BALL VALVE: DPS Positioner version									
550502	1/4	11.5	69	9	IP67	0.30	0.16	1.28	0.97
550503	3/8	12.5	69	9	IP67	0.30	0.16	1.28	0.97
550504	1/2	15.0	69	9	IP67	0.30	0.16	1.28	0.97
550506	3/4	20.0	69	9	IP67	0.30	0.16	1.28	0.97
550508	1	25.0	69	9	IP67	0.30	0.16	1.28	0.97
550510	1-1/4	32.0	69	13	IP67	0.43	0.21	1.98	1.63
550512	1-1/2	38.0	69	13	IP67	0.43	0.21	1.98	1.63
550516	2	50.0	69	13	IP67	0.43	0.21	1.98	1.63
550520	2-1/2	65.0	55	29	IP67	0.33	0.18	1.50	1.22
550524	3	80.0	55	58	IP67	0.77	0.47	3.30	2.70

* Pressure at 70° C (reduced pressures at higher temperatures- see P/T chart)

Models with 240 volt range are single phase

Pressure/Temperature Chart (Bar/°C)

P/T Chart 69 Bar				
Bar	69	69	7	0
°C	-20	10	166	200

P/T Chart 55 Bar				
Bar	55	55	7	0
°C	-20	10	166	200

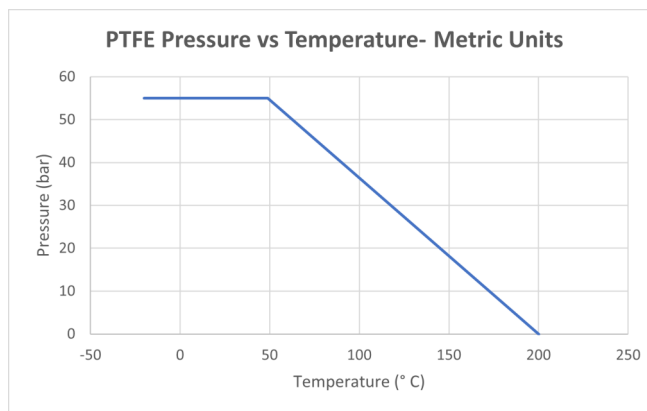
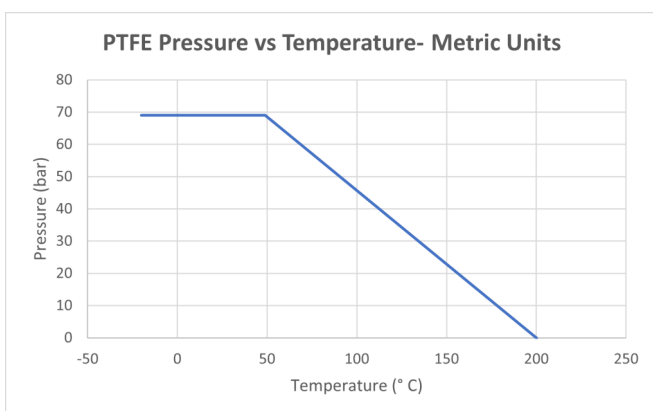

CV vs Valve Position

Size	V	0	10%	20%	30%	40%	50%	60%	70%	80%	90%	100%
1/4"	30°	0.000	0.000	0.082	0.141	0.266	0.352	0.533	0.717	1.109	1.437	2.000
	60°	0.000	0.000	0.099	0.194	0.443	0.528	0.888	1.304	2.148	3.010	4.538
	90°	0.000	0.082	0.164	0.329	0.493	0.657	1.232	1.807	3.121	4.436	5.668
3/8"	30°	0.000	0.000	0.089	0.154	0.289	0.383	0.579	0.779	1.205	1.562	2.174
	60°	0.000	0.000	0.107	0.211	0.481	0.574	0.965	1.417	2.335	3.271	4.933
	90°	0.000	0.089	0.179	0.357	0.536	0.714	1.339	1.964	3.393	4.821	6.161
1/2"	30°	0.000	0.000	0.100	0.172	0.324	0.429	0.649	0.873	1.350	1.749	2.435
	60°	0.000	0.000	0.120	0.236	0.539	0.643	1.081	1.587	2.615	3.664	5.525
	90°	0.000	0.100	0.200	0.400	0.600	0.800	1.500	2.200	3.800	5.400	6.900
3/4"	30°	0.000	0.000	0.128	0.159	0.338	0.489	0.850	1.166	1.805	2.408	2.884
	60°	0.000	0.000	0.151	0.238	0.453	0.729	1.275	1.915	3.419	4.630	6.440
	90°	0.000	0.200	0.400	0.800	1.200	2.000	3.100	4.600	8.000	11.300	14.000
1"	30°	0.000	0.030	0.312	0.436	0.659	0.986	1.539	2.129	2.921	4.045	4.761
	60°	0.000	0.030	0.445	0.607	0.790	1.417	2.308	3.318	5.270	7.568	10.108
	90°	0.000	0.200	0.600	1.800	3.400	5.100	8.100	11.400	16.000	21.000	29.000
1-1/4"	30°	0.000	0.050	0.359	0.857	1.661	2.686	4.044	6.186	8.530	11.193	13.230
	60°	0.000	0.060	0.441	1.114	1.845	3.426	5.575	8.215	13.290	18.360	24.499
	90°	0.000	0.300	0.800	2.000	5.000	8.000	14.000	19.000	28.000	39.000	55.000
1-1/2"	30°	0.000	0.050	0.410	1.099	1.995	3.430	4.230	7.432	10.230	13.540	16.126
	60°	0.000	0.060	0.570	1.556	2.849	5.488	7.077	12.908	19.665	28.068	37.099
	90°	0.000	0.400	0.900	3.500	7.000	13.000	20.000	31.000	42.000	63.000	78.000
2"	30°	0.000	0.050	0.549	1.620	3.320	5.574	8.252	11.931	16.397	21.797	26.234
	60°	0.000	0.060	0.698	2.477	4.784	9.094	15.410	21.889	31.707	46.343	60.981
	90°	0.000	0.500	2.000	6.000	12.000	22.000	35.000	45.000	70.000	105.000	135.000
2-1/2"	30°	0.000	0.060	0.750	2.610	5.907	10.153	15.210	22.440	30.620	41.270	49.400
	60°	0.000	0.090	0.955	3.699	7.100	13.199	22.222	31.972	46.028	68.120	89.400
	90°	0.000	0.500	1.700	7.000	14.000	28.000	48.000	70.000	106.000	160.000	218.000
3"	30°	0.000	0.100	0.955	3.115	6.400	10.364	16.661	24.500	33.650	44.300	53.880
	60°	0.000	0.120	1.000	4.156	9.943	18.514	28.984	48.566	66.704	93.350	123.860
	90°	0.000	0.700	3.500	8.000	18.000	35.000	60.000	90.000	135.000	205.000	310.000

Specifications (CV)

Cv vs % Open, 30° V Port

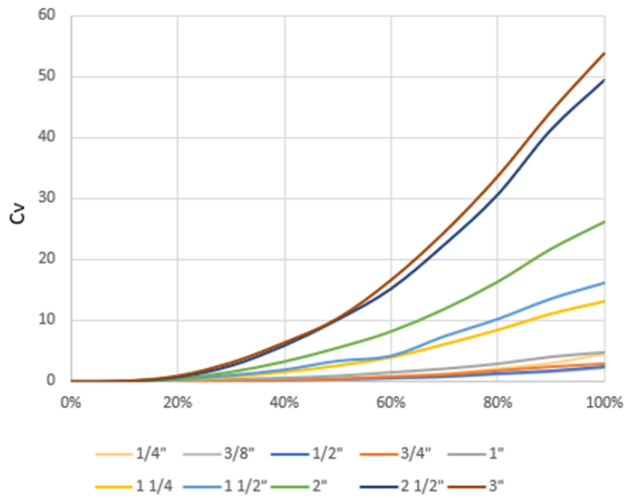

Cv vs % Open, 60° V Port

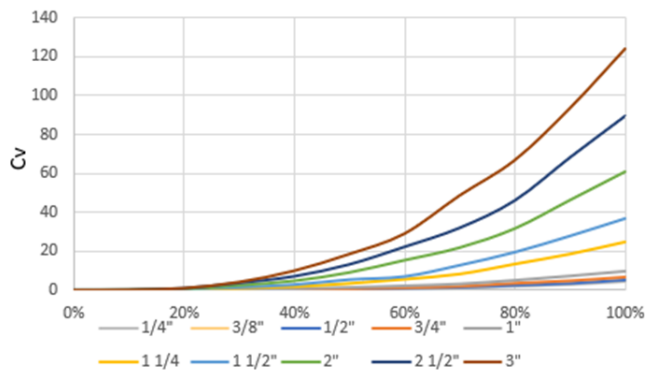

Cv vs % Open, 90° V Port

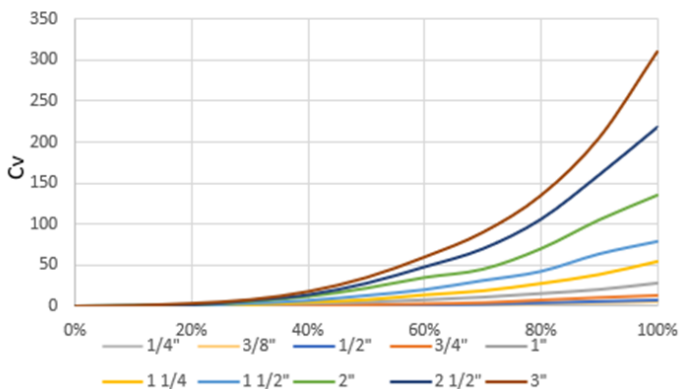

Polynomial Best Fit

$$Cv = Ax^2 + Bx + C$$

where x = % open

30°	A	B	C
1/4	2.5142	-0.6735	0.0601
3/8	2.7329	-0.7323	0.0655
1/2	3.0597	-0.8189	0.0732
3/4	3.7579	-0.8844	0.0566
1	5.5478	-0.8243	0.0903
1 1/4	15.9160	-2.4360	0.0835
1 1/2	19.9630	-3.6943	0.1823
2	31.0550	-4.5772	0.1215
2 1/2	60.1080	-10.0700	0.2174
3	65.6310	-11.3300	0.3235

60°	A	B	C
1/4	6.7175	-2.7591	0.2241
3/8	7.3027	-3.0000	0.2435
1/2	8.1790	-3.3599	0.2728
3/4	9.9126	-4.0308	0.2960
1	14.6730	-5.3902	0.4561
1 1/4	35.8110	-12.8860	0.8933
1 1/2	55.2470	-20.5430	1.4205
2	86.4620	-28.9610	1.8044
2 1/2	127.4300	-43.2490	2.7312
3	174.7300	-56.8050	3.1735

90°	A	B	C
1/4	8.6168	-3.33148	0.2769
3/8	9.3662	-3.6033	0.3010
1/2	10.4900	-4.0350	0.3371
3/4	20.9210	-7.5844	0.6154
1	36.3520	-5.3902	0.4561
1 1/4	76.3400	-25.9400	1.8056
1 1/2	108.1000	-32.3910	1.9378
2	190.7900	-63.7020	4.3916
2 1/2	329.2900	-129.2100	8.7343
3	478.5200	-208.7300	15.5370

Digital Positioner System

The DPS Digital Positioner System is factory installed for Valworx 5505 series electric actuated valves. This will allow positioning of the actuator output drive anywhere between 0 and 90° using a 4-20mA input command signal. When using an electric actuated valve with DPS option, the output flow can be adjusted anywhere between 0-100%.

The DPS kit contains a microprocessor based control board and mounting hardware. The control board continuously monitors the analog input and output signals and compares them to the actual physical position of the output drive. An electric motor/gear drive moves the actuator output drive as required to balance the signals and find the desired position. The digital microprocessor ensures highly sensitive and repeatable control. The DPS is installed inside the actuator, under the red cover.



The DPS system provides an accurate valve positioning function whereby the movement of the actuator is controlled by a 4-20mA control signal. Any change in the control input signal results in a corresponding and proportional change in the position of the actuator (valve).

The DPS positioner has auto-calibration, no need to adjust zero and span settings. An output monitoring signal, in the same format as the input signal is also provided to confirm the output drive position (ex: 4-20mA input, 4-20mA output).

The standard DPS actuator will fail closed with loss of the control signal. Actuator can also be setup reverse-acting (4mA = open) and fail open with loss of the control signal. These electric actuators will fail in place with loss of external power.

DPS Positioner Kit Installed

Kit Stock No.	Input Signal	Valve Sizes
561101E	4-20mA	1/2 to 2" NPT
561108C	4-20mA	2-1/2 to 3" NPT

• Kits are a factory installed option. The DPS kit is automatically installed and tested when ordered with an actuated valve.

Rotation	0-90°
Input Signal	4-20mA
Output Signal	4-20mA
Accuracy	3% Full Scale
Linearity	2% Full Scale
Hysteresis	3% Full Scale
Steps	4/20mA: Min. 150 steps
Impedance 4-20mA	100 Ohms

Note: Overall accuracy of a valve assembly will vary depending on the type of valve selected and how the valve is mounted to the actuator. Output signals will be in the same format as input signal (ex: 4-20mA input, 4-20mA output).

Positioning Actuators Specifications

	5610 Series
Accuracy	3% F.S.
Linearity	2% F.S.
Deadband	3% F.S.
Resolution (4- 20mA)	Min 150 steps
Resolution (0- 10V)	Min 98 steps
Impedance	100 Ohm
Actuator Ordering Information	Factory installed accessory

Optional BSR - Battery Spring Return

The BSR– Battery Spring Return kit is available as a factory installed option for Valworx 5505 series electric actuated valves. The BSR kit will work with both on-off models and actuators with DPS positioners. The battery failsafe system provides an alternative source of power to drive the actuator to a preset failsafe position in the event of an external power failure. The industrial quality battery is constantly trickle charged during normal operation to assure maximum charge when required. The battery kit is installed under the actuator cover. No separate modules or boxes are required.

In many applications, the BSR battery spring return function tends to be a very economical option when compared to the alternate true mechanical spring return actuator. Valworx actuators with the BSR option are much smaller, lighter and less expensive.



The installed BSR kit will provide enough power to move the actuator/valve to a fail-safe position with loss of external power. The kit can be ordered as fail closed or fail open as required.

The actuator operates in the normal power open and power close mode while external power is available. Internal circuitry monitors the incoming main power and automatically switches within a few seconds to the battery backup with loss of external power. The battery will then provide enough power to move the actuator to a failsafe position. Under normal operation the external control power will trickle charge the battery and maintain a full charge.

In the normal mode of operation, an LED status light located on top of the actuator cover will be continuously lit. With a loss of power, the LED status light will blink slowly. On resumption of external power, conditional that the actuator control signal remained unchanged, the actuator will reset to the position it saw at the time of the main power failure.

BSR Kit Ordering

Kit Stock Number	Description	Valve Sizes
561104E	5610 BSR Battery Spring Return Kit, Fail Closed	1/2 to 2" NPT
561105E	5610 BSR Battery Spring Return Kit, Fail Open	1/2 to 2" NPT
561106C	5616 BSR Battery Spring Return Kit, Fail Closed	2-1/2 to 3" NPT
561107C	5616 BSR Battery Spring Return Kit, Fail Open	2-1/2 to 3" NPT

• Kits are a factory installed option. The BSR kit is automatically installed and tested when ordered with an actuated valve.

Actuated Valve with	1/2 to 1"	1-1/4 to 2"	2-1/2 to 3"
Working operations without recharge, with 100% initial battery charge	10 operations	10 operations	4 operations
Recharge time per working operation	15 min	48 min	50 min
Full Charge Time 100%	28 h	28 h	54 h

Electrical Wiring: Actuators with DPS Digital Positioner Option

Voltage: 24-240 Volts AC or DC, 1 ph, (auto-voltage sensing)

Control Signal: 4-20mA

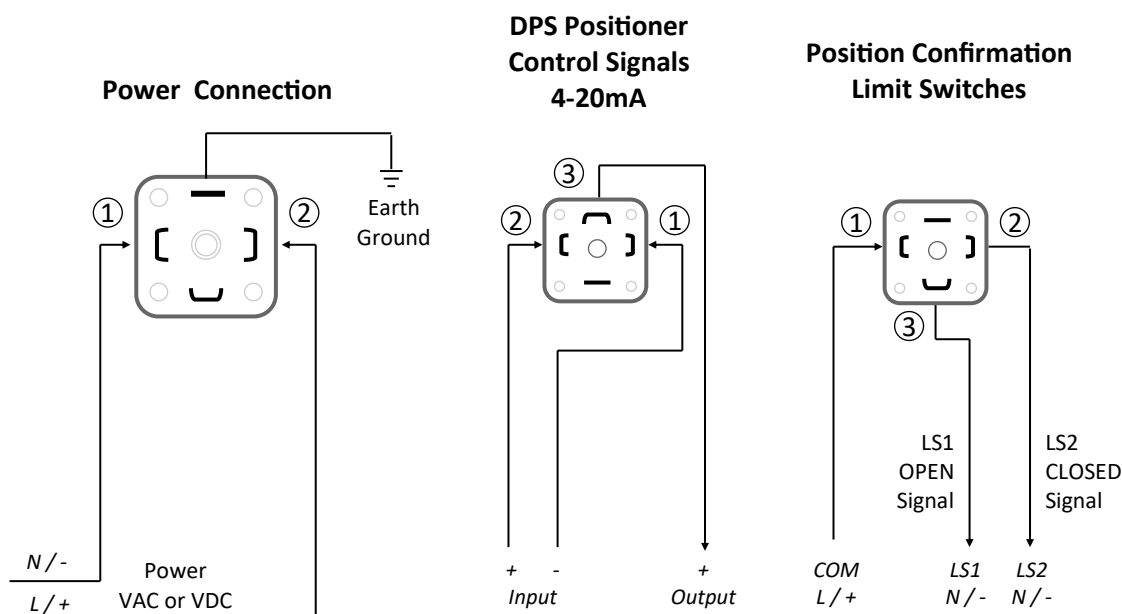

Function: Actuators with DPS—Digital Positioner Option

Power open, power close - actuator movement controlled by 4-20mA input signal.
 Standard operation: 4mA = actuator closed, 20mA = actuator open (can be setup reverse acting).
 Actuator closes with loss of control signal, stays in last known position with loss of main power.
 Output monitoring signal (in same format as supply signal) provided as standard.

Function: Position confirmation limit switches

Dry contact 3A @ 125/250 VAC, 30VDC resistive load
 PIN 1 (COM) and 2 to confirm actuator is closed
 PIN 1 (COM) and 3 to confirm actuator is open

Dimensions 1/2 to 3 inch: inches (mm)

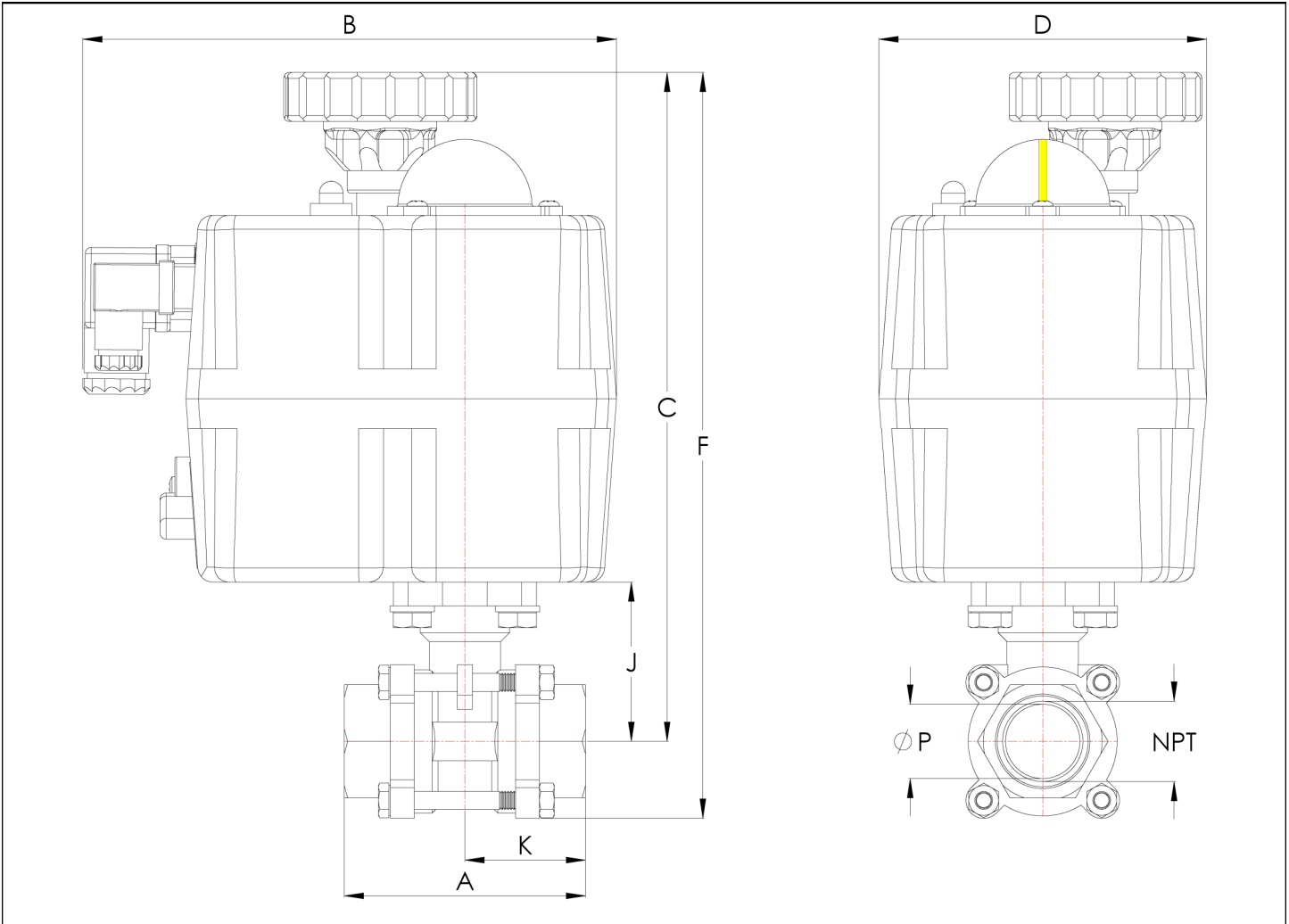

Pipe Size (NPT)	A	B	C	D	F	J	K	P	Weight lbs (kg)
1/4"	2.5 (63.5)	7.1 (179.0)	8.2 (208.3)	4.3 (110.0)	9.1 (231.1)	1.5 (37.0)	1.4 (35.0)	0.5 (11.5)	5.2 (2.4)
3/8"	2.5 (63.5)	7.1 (179.0)	8.2 (208.3)	4.3 (110.0)	9.1 (231.1)	1.5 (37.0)	1.3 (32.4)	0.5 (12.5)	5.4 (2.4)
1/2"	2.5 (63.5)	7.1 (179.0)	8.2 (208.3)	4.3 (110.0)	9.1 (231.1)	1.5 (37.0)	1.3 (32.4)	0.6 (15.0)	5.2 (2.4)
3/4"	2.9 (72.5)	7.1 (179.0)	8.5 (215.9)	4.3 (110.0)	9.3 (236.2)	1.8 (45.0)	1.4 (36.3)	0.8 (20.0)	5.6 (2.5)
1"	3.2 (81.0)	7.1 (179.0)	8.8 (223.5)	4.3 (110.0)	9.9 (251.5)	2.1 (53.5)	1.6 (40.5)	1.0 (25.0)	6.3 (2.9)
1-1/4"	3.7 (94.5)	7.0 (177.0)	10.0 (254.0)	4.3 (110.0)	11.3 (287.0)	2.3 (59.0)	1.9 (47.3)	1.3 (32.0)	8.8 (4.0)
1-1/2"	4.3 (108.0)	7.0 (177.0)	10.6 (269.0)	4.3 (110.0)	12.1 (307.3)	2.9 (74.8)	2.1 (54.0)	1.5 (38.0)	10.7 (4.9)
2"	4.8 (122.0)	7.0 (177.0)	11.0 (279.4)	4.3 (110.0)	12.8 (325.1)	3.3 (83.5)	2.4 (60.8)	2.0 (50.0)	13.1 (5.9)
2-1/2"	6.2 (158.0)	7.0 (177.0)	12.0 (304.8)	4.3 (110.0)	14.2 (360.7)	4.3 (108.8)	3.1 (87.8)	2.6 (65.0)	22.9 (10.4)
3"	7.5 (190.0)	9.1 (232.0)	14.7 (373.4)	8.5 (217.0)	17.3 (439.4)	4.7 (118.3)	3.7 (95.0)	3.2 (80.0)	36.2 (16.4)